

1. Safety



Assembly and installation should only be carried out by a qualified electrician, somebody who has completed appropriate professional training and has the knowledge and experience necessary to be able to recognise and avoid the potential dangers posed by electricity.



Before assembly/dismounting, disconnect the power supply and ensure that the parts are no longer live.



Prior to commissioning and using the product, read and observe all the operating instructions.

- Corresponds to type 1 BSTU in accordance with IEC/EN 60730-2-7
- Power reserve (6 years) is reduced when Bluetooth OBELISK top3 is connected (in battery mode)

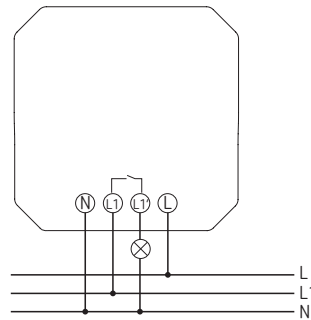

⚠ Secure device with an upstream type B or type C circuit breaker (EN 60898-1) with a maximum of 10.

Connecting the cable

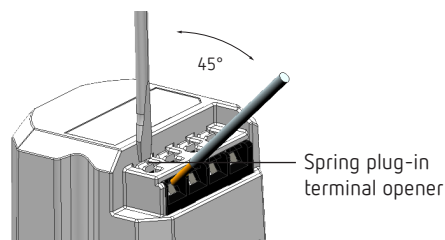

- Strip cable to 8 mm (max. 9).
- Insert cable in the open DuoFix plug-in terminal at 45°.
- ⓘ 2 cables per terminal position possible.
- To open the DuoFix plug-in terminal, press screwdriver downwards.

Disconnecting the cable

- Use the screwdriver to push the spring plug-in terminal downwards.

2. Proper use

- Digital time switch with weekly program and 3 special programs
- Interface for Bluetooth OBELISK top3
- Programming by app possible
- The time switch is intended for time-controlled and manual switching of lights, fans etc.
- Only for use in closed, dry rooms
- The time switch is designed for wall mounting (flush-mounting) in an interior switch range

3. Installation and connection

Flush-mounted installation

- ⓘ With a standard flush-mounting box (see illustration).
- ⓘ Observe the recommended installation height of 0.8 m–1.2 m!

- Disconnect power source.
- Connect the time switch according to the wiring diagram.
- Screw down the time switch in the flush-mounted box ①.
- Position the bezel frame on the time switch ②.

4. Device description

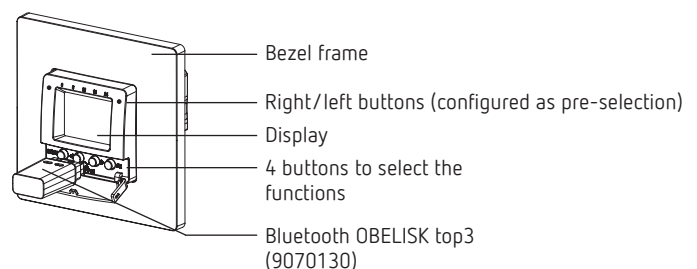

Display & buttons

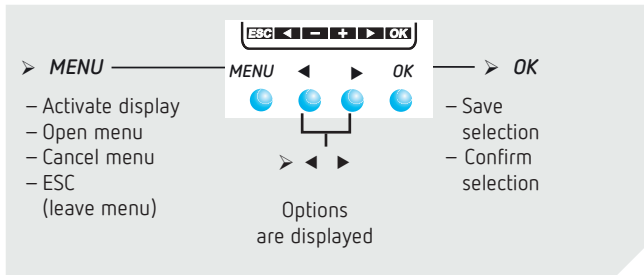
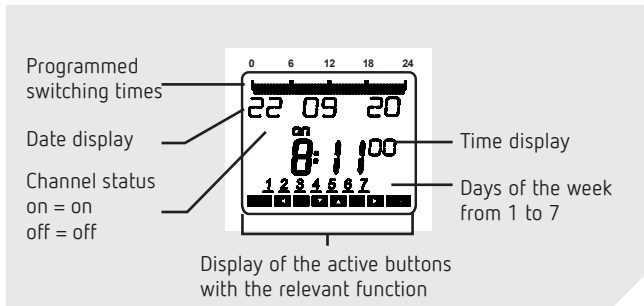

Operating instructions

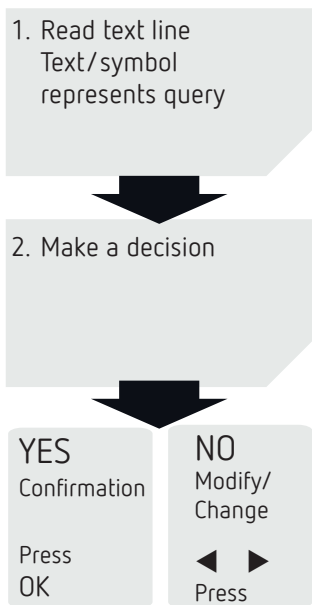

Function of the right/left buttons

The right and left buttons can be used, for example, to switch the light on and off or to control a fan, etc. Pressing the right/left buttons changes the relay state in question and the program performs the next switching operation.

Overview of navigation menu

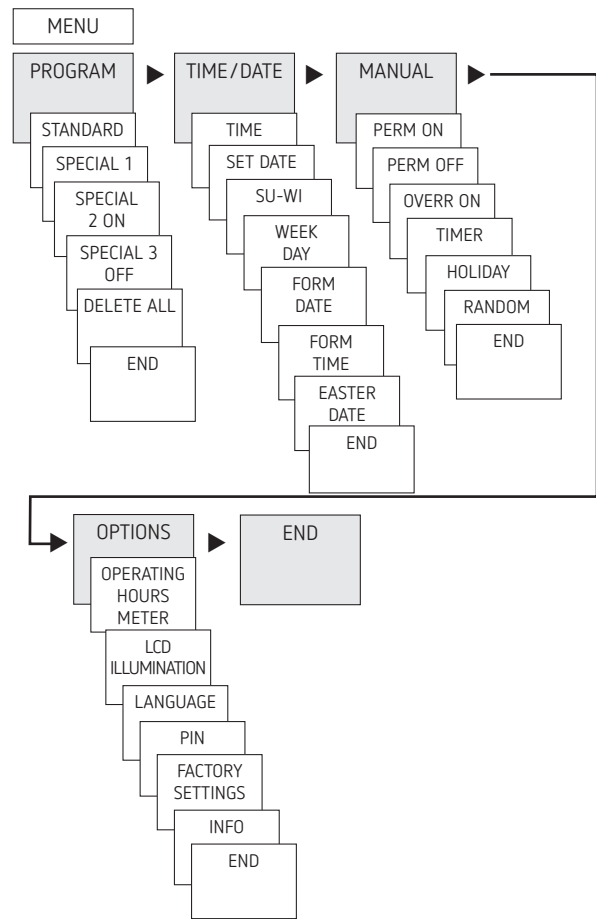

Initial operation

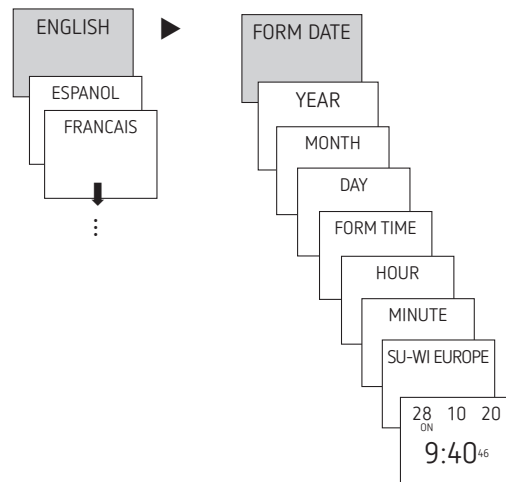

- Set language, date, time as well as summer/winter time (SU-WI).
- Press any button and follow on-screen instructions (see picture).

5. Settings and functions

Setting the switching time

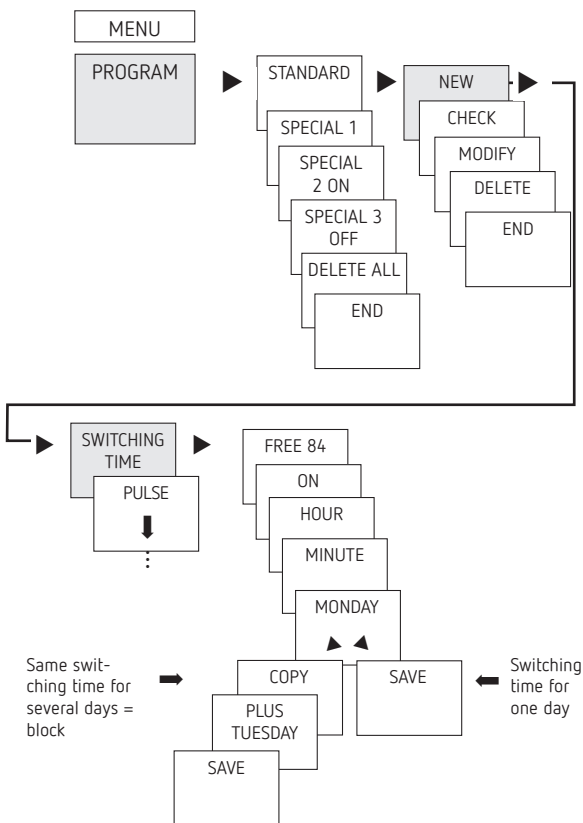

① A switching time always consists of an ON switching operation and an OFF switching operation.

② There are 84 memory cells available.

Example: Switch on sports hall lighting from Mon–Fri, 7:30 to 12:00

- Press MENU.
- Select PROGRAM, confirm with OK.
- Select STANDARD, confirm with OK.
- Select NEW, confirm with OK.
- Select SWITCHING TIME, confirm with OK.
- Select ON (for turn-on time) or OFF (for turn-off time), confirm with OK.
- Set required turn-on time (Mo–Fr, 7:30), confirm with OK.
- Select COPY, confirm with OK.
- PLUS TUESDAY is displayed, confirm by pressing OK and also confirm the days We, Th, Fr by pressing OK.
- Continue with ► until SAVE is displayed.
- Confirm with OK.

Repeat all steps for the turn-off time, however instead of selecting ON with ► select OFF and enter 12:00 for hour and minute.

Changing switching times

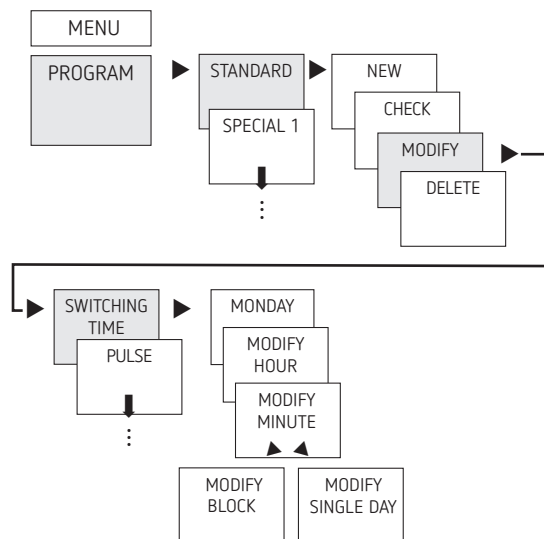

③ You can either modify a block, i.e. a switching time copied for several days (e.g. Mon–Fri) or a single switching time.

Modifying individual switching times

- Press MENU.
- Select PROGRAM, confirm with OK.
- Select STANDARD, confirm with OK.
- Select MODIFY, confirm with OK.
- Select SWITCHING TIME, confirm with OK.
- Select day, confirm with OK.
- MODIFY HOUR, use the + or – buttons to change hour and minute and confirm with OK.
- To change several switching times, select MODIFY BLOCK, confirm with OK.

Deleting a switching time

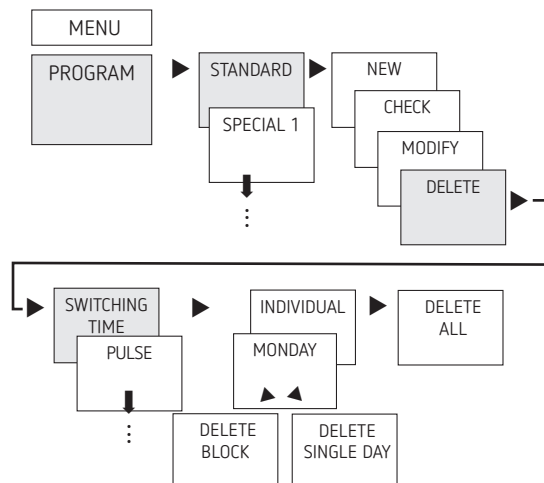

④ You can either delete a block, i.e. a switching time copied for several days (e.g. Mon–Fri) or a single switching time.

- Press MENU.
- Select PROGRAM, confirm with OK.
- Select STANDARD, confirm with OK.
- Select DELETE, confirm with OK.
- Select SWITCHING TIME, confirm with OK.
- INDIVIDUAL is displayed (with ► DELETE ALL), confirm with OK.
- MONDAY is displayed, confirm with OK.
- Select DELETE BLOCK, confirm with OK.
- With ► DELETE MONDAY etc. individual days can also be deleted.

Pulse programming

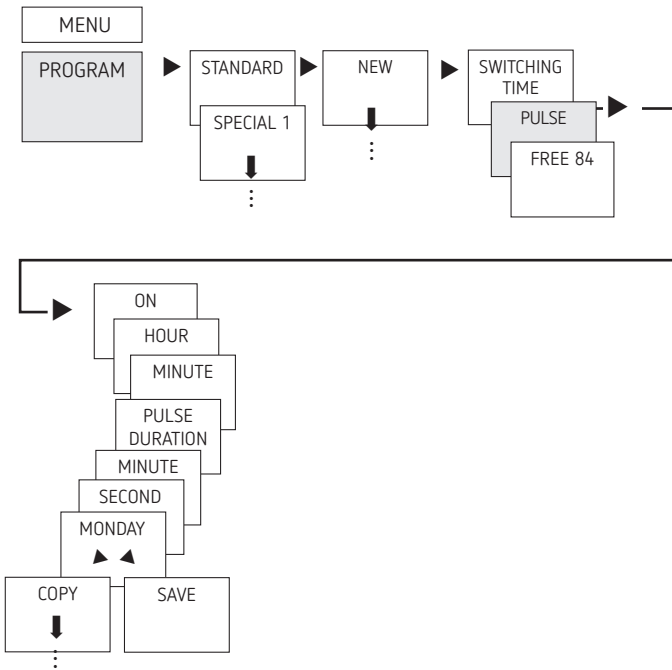

Example: Switch on pause signal on Monday at 8:05 for 5 sec.

- Press MENU.
- Select PROGRAM, confirm with OK.
- Select STANDARD, confirm with OK.
- Select NEW, confirm with OK.
- With ► select PULSE, confirm with OK.
- Select ON, confirm with OK.
- Use the + or – buttons to enter hour, minute, second (8:05) and confirm with OK.
- Use the + or – buttons to enter the duration of the pulse in minutes and seconds (5 sec) and confirm with OK. MONDAY is displayed.
- Select day, confirm with OK.
- Select COPY or SAVE.
- To save press ► and confirm with OK.
- To copy press OK.

Cycle programming

In addition to turn-on and turn-off times (switching time) and short time pulses (pulse), cycle times (cycle) can also be programmed. The pulse duration (+ pulse pause) is limited to 17 hrs, 59 min, 59 sec.

- ① Cycle times are cyclically repetitive time functions such as fan controls, urinal rinses, etc.

Example: Switch on water rinsing Monday from 8:00 to 20:30 every 15 min. for 20 s (8:00:00–8:00:20 On; 8:15:00–8:15:20 On; 8:30:00–8:30:20 On, etc.)

Cycle programming:

- Start cycle: Monday 8:00
- Pulse duration: 20 s
- Pause duration (pause): 14 min and 40 s
- End cycle: Monday 20:30

- ① Observe the maximum number of electrical switching cycles when using the cycle function.

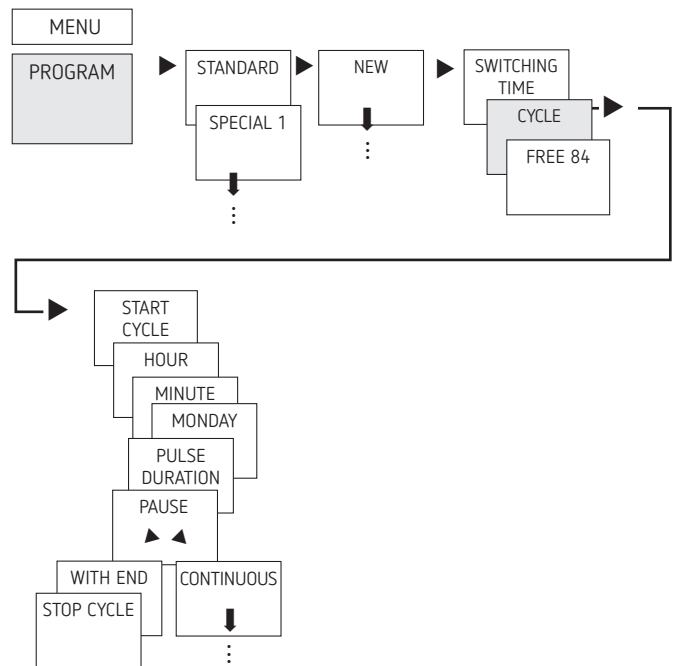

- Press MENU.
- Select PROGRAM, confirm with OK.
- Select STANDARD, confirm with OK.
- Select NEW, confirm with OK.
- With ► select CYCLE, confirm with OK.
- START CYCLE is displayed, confirm with OK.
- Use the + or – buttons to enter hour, minute, day (8:00 Monday) and confirm with OK.
- Enter PULSE DURATION (20 s), confirm with OK.
- Enter pause duration PAUSE (14 min and 40 s), confirm with OK.
- Select WITH END, confirm with OK.
- STOP CYCLE is displayed, confirm with OK.
- Enter end times of the cycle (20:30) and confirm with OK.

Setting special programs

Two on/off switching pairs that are not specific to particular weekdays can be programmed and activated for the set date ranges.

- ① For the two-channel devices, the special programs can be set individually for each channel.

Special program 1

Set 2 turn-on and turn-off times individually based on the date ranges.

- Fixed date
- Fixed date each year
- Easter date
- Public holiday set (only via app or OBELISK)

Special program 2

Set switch-on based on the date ranges.

- Fixed date
- Fixed date each year
- Easter date
- Public holiday set (only via app or OBELISK)

Special program 3

Set switch-off based on the date ranges.

- Fixed date
- Fixed date each year
- Easter date
- Public holiday set (only via app or OBELISK)

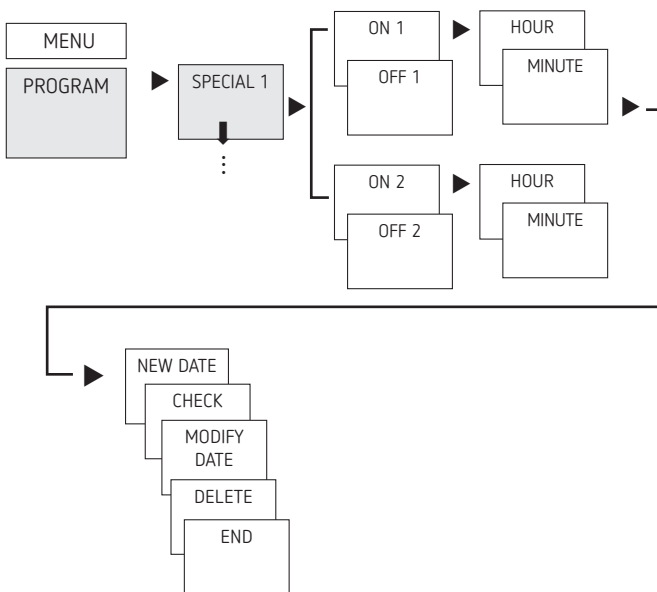

- Press MENU.
- Select PROGRAM, confirm with OK.
- Select SPECIAL 1, confirm with OK.
- ON 1 (for turn-on time) is displayed.
- Set required turn-on time, confirm with OK.
- OFF 1 (for turn-off time) is displayed.
- Set required turn-off time, confirm with OK.
- Repeat process for ON 2 and OFF 2.

Setting holiday function

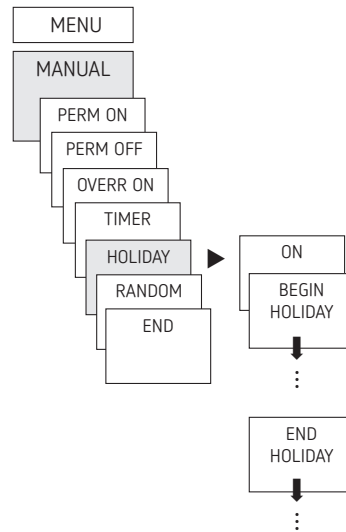

- Press MENU.
- Select MANUAL, confirm with OK.
- Select HOLIDAY, confirm with OK.
- Select ON, confirm with OK.
- Select BEGIN HOLIDAY, confirm with OK.
- Enter YEAR, MONTH, DAY, HOUR, confirm with OK.
- Select END HOLIDAY, confirm with OK.
- Enter YEAR, MONTH, DAY, HOUR, confirm with OK.

Activating PIN code

The PIN code is set in OPTIONS via the menu.

- ① If you have forgotten your PIN, please call the Theben Hotline.
- ① Have the serial number ready.

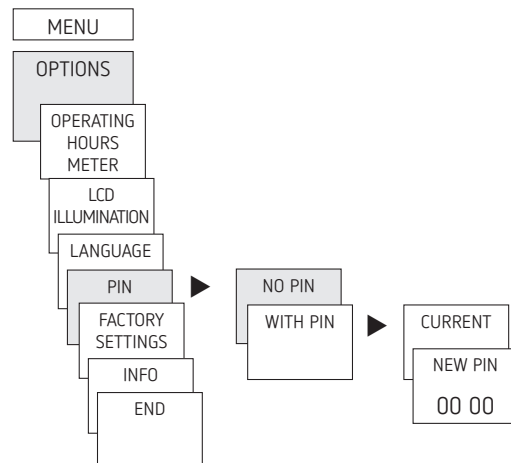

Setting manual control or permanent switching

Manual control or permanent switching can be set via the menu in MANUAL or (in the automatic display) by button combination (see picture).

- Manual control:
Reversing the channel status until the next automatic or programmed switch.
- Permanent switching:
As long as permanent switching (on or off) is activated, the programmed switching times are ineffective.

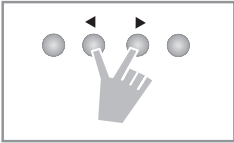

Activating manual control

- Briefly press both buttons simultaneously.

Activating permanent switching

- Press both buttons simultaneously for 2 s.

Cancelling manual control/permanent switching

- Press both buttons simultaneously.

Hour counter

The operating hours of the channel (relay) are displayed and deleted in the OPTIONS menu. If the number of operating hours exceeds the value set in the Service menu, SERVICE will appear in the display.

Example: Replace a lamp after 5000 h.

- Delete operating hours or set a higher value in Service (e.g. 10,000 h).

Using Bluetooth OBELISK top3

All functions can also be transferred to the time switch using the Bluetooth OBELISK top3 memory card (accessory 9070130).

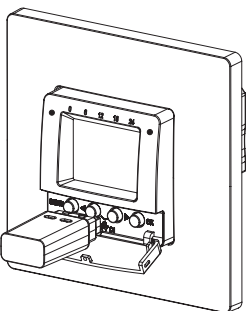

Copying OBELISK → TIME SWITCH

This copies the switching program and optionally all time switch settings (e.g. time format, etc.) from the memory card to the time switch.

Copying TIME SWITCH → OBELISK

This copies all switching programs and settings from the time switch to the memory card.

Starting OBELISK program

Takes over the switching times that are programmed on the memory card.

As soon as the memory card is removed, the switching times of the time switch are re-activated.

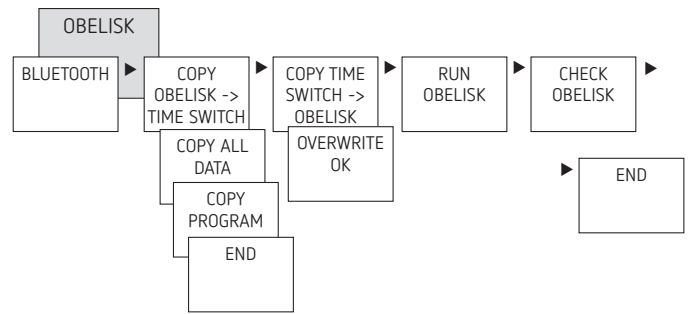



Connecting time switch, Bluetooth OBELISK top3 and smartphone (via app)

The devices in the top3 range can be programmed using an app (for Android, iOS) on a mobile end device. Communication takes place via Bluetooth OBELISK top3. Switching programs are transferred and direct switch commands are sent to the device.

- Download the OBELISK top3 app from the App Store or Google Play Store.



ⓘ Bluetooth connection only possible in automatic mode, not in manual mode like OPTIONS, etc.

- Open the app and activate using one of the 3 commands, by pressing "Download" , "Manual command"  or "Upload" .

→ Device/device list appears on the display.

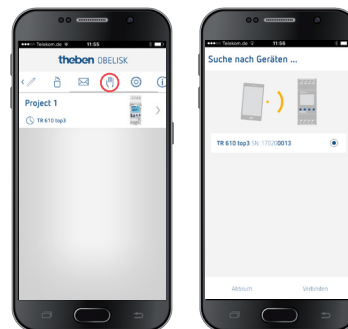

- Press "Connect".



- Press OK on the time switch.
→ The display shows BLUETOOTH ACTIVE.
- Press "Close" in the app within 30 s.

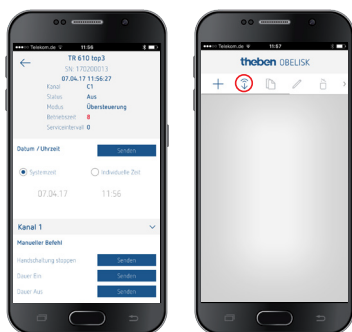

Now, for example, projects can be created and uploaded.

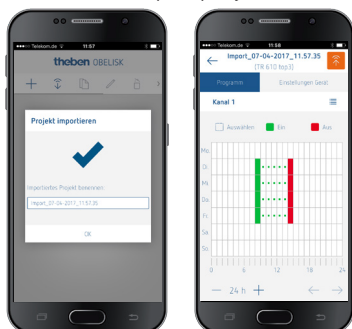

Resetting the time switch

- Press the 4 buttons simultaneously.
→ You can now choose between RETAIN PROGRAMS and DELETE PROGRAMS.

6. Technical data

Operating voltage:	230 V AC, +10% / -15%
Frequency:	50 Hz
Standby:	0.4 W
Max. switching capacity:	10 A (at 250 V, $\cos \varphi = 1$)
Switching capacity:	2 A (at 250 V, $\cos \varphi = 0.6$)
Min. switching capacity:	10 mA / 230 V AC 100 mA / 24 V AC / DC
Shortest switching time:	1 min
Switching accuracy:	To the second
Protection rating:	IP 20 in accordance with EN 60529
Protection class:	II in accordance with EN 60730-1 subject to designated installation
Software:	Class A
Operating temperature:	-5 °C ... +45 °C
Power reserve:	6 years at +20 °C (without Bluetooth OBELISK top3)

Time accuracy (typical):	± 0.25 s/day (25 °C)
Rated impulse voltage:	4 kV
Pollution degree:	2
Contact:	NO contact (μ)
Incandescent lamp / halogen lamp load:	2300 W at 25 °C 2000 W at 35 °C 1300 W at 45 °C
Fluorescent lamp load: uncorrected series-corrected: parallel-corrected:	2000 VA 2000 VA 1300 VA (130 μ F)
Compact fluorescent lamps (EVG):	1100 W
LED lamps (< 2 W):	50 W
LED lamps (> 2 W):	600 W
Bluetooth OBELISK top3:	
– Protection rating:	IP 40
– Temperature:	-30 °C ... +55 °C
– Range:	15 m on open air test site

Cleaning and service

- Only use a dry, soft cloth to clean the device surface.
- Do not use any cleaning agents or solvents.

Disposal

- Dispose of device in environmentally sound manner (electronic waste).

7. Dimensional drawings

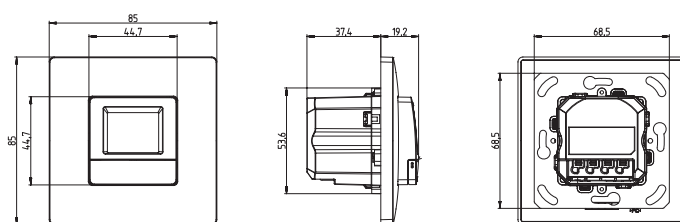

8. Contact

Theben AG
Hohenbergstr. 32
72401 Haigerloch
GERMANY
Phone +49 7474 692-0
Fax +49 7474 692-150

Hotline

Phone +49 7474 692-369
hotline@theben.de

Addresses, telephone numbers etc.
www.theben.de